

### ASX-312B/312BT/312W/312WT ASX-612B/612BT/612W/612WT ASX-912B/912BT/912W/912WT

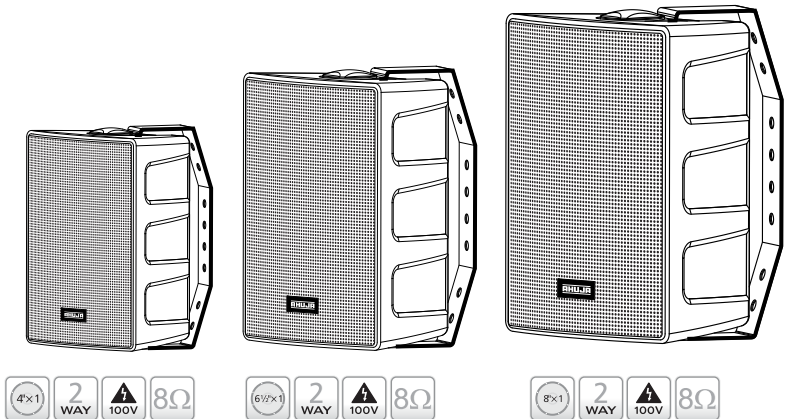

High fidelity 2-Way speaker system in compact & attractive Black or White plastic housing. The suffix B & BT denote Black cabinet, and W & WT denote White cabinet. Ideal for various indoor and outdoor (under eaves) applications in Airports, Banks, Schools, Hotels, Restaurants, Lounges, Hospitals, Showrooms etc.

- Comprises of a Water Resistant PP coated cone Woofer, a Titanium Dome Tweeter and a 2-way Crossover Network.
- ASX-312B, ASX-312W, ASX-612B, ASX-612W and ASX-912B, ASX-912W are low impedance  $8\Omega$  speakers.
- ASX-312BT and ASX-312WT are for use on 100V line with power taps of 30W, 20W, 15W, 10W & 5W.
- ASX-612BT and ASX-612WT are for use on 100V line with power taps of 60W, 40W, 30W, 20W & 10W.
- ASX-912BT, are for use on 100V line with power taps of 90W, 60W, 30W, & 15W.
- Easy power tap selection through a slotted rotary switch knob at the rear.
- 'U' type bracket for convenient & firm mounting of the wall speaker.

# • Installation Instructions

## Mounting Bracket for ASX-312BT/312WT

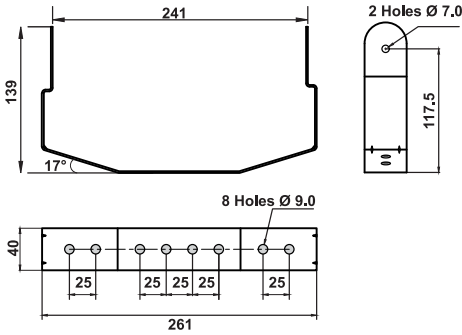

## Mounting Bracket for ASX-612BT/612WT

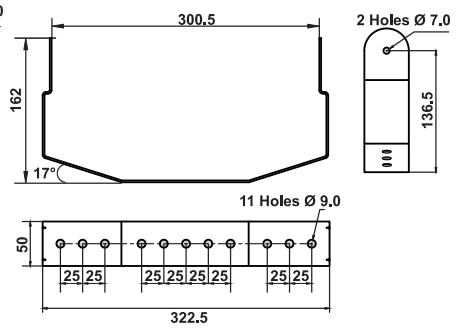

## Mounting Bracket for ASX-912BT/912WT

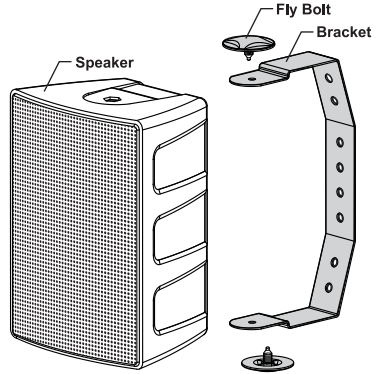
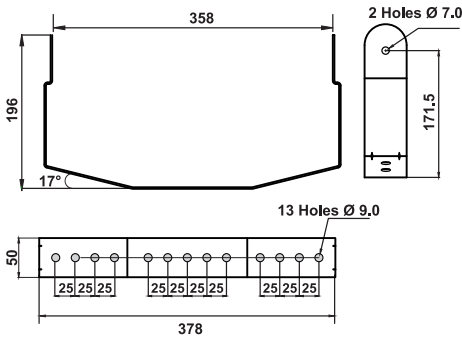

The speaker system is supplied with specially designed mounting bracket. It helps in the installation of this speaker system in three positions i.e, Vertical, Horizontal and Inclined.

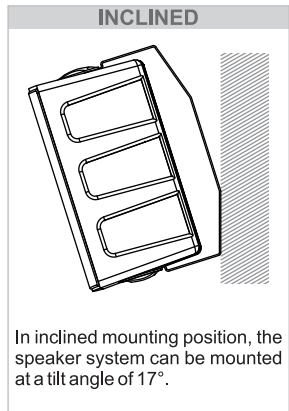
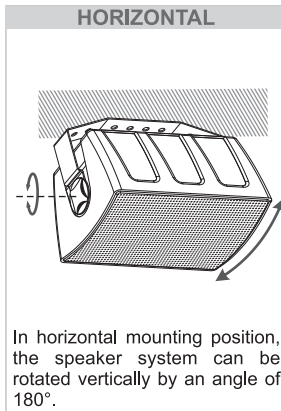
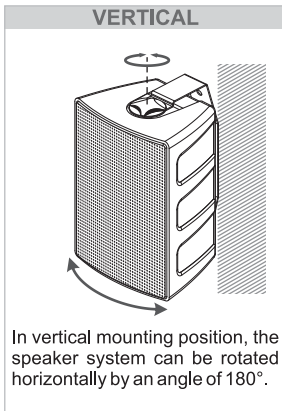

**POWER TAP SELECTION**

**ASX-312BT/312WT**

**ASX-612BT/612WT**

**ASX-912BT/912WT**

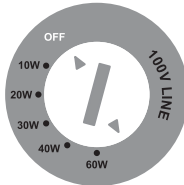
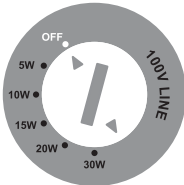
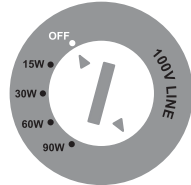
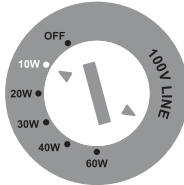
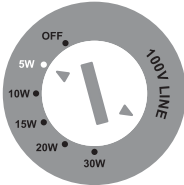
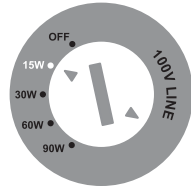
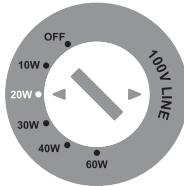
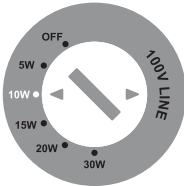
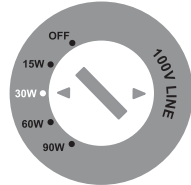
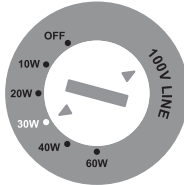
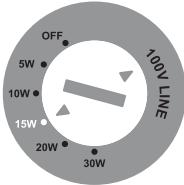
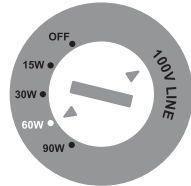
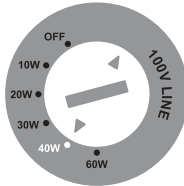
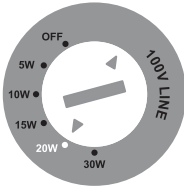
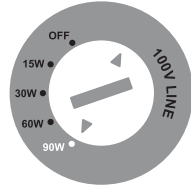
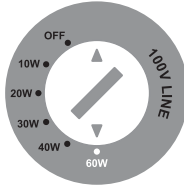
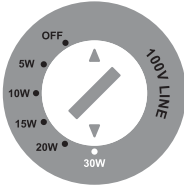

## • Specifications

	<b>ASX-312B/312BT 312W/312WT</b>	<b>ASX-612B/612BT 612W/612WT</b>	<b>ASX-912B/912BT 912W/912WT</b>
<b>POWER RATING</b>	30W RMS / 45W Max.	60W RMS / 90WMax.	90W RMS / 135W Max
<b>POWER TAPS</b>	30W, 30/20/15/10/5W	60W, 60/40/30/20/10W	90W, 90/60/30/15W
<b>IMPEDANCE/</b>	8Ω/	8Ω/	8Ω/
<b>VOLTAGE</b>	100V	100V	100V
<b>FREQUENCY RESPONSE</b>	75-20,000Hz	50-20,000Hz	55-20,000Hz
<b>SPL at 1KHz (1W/1m)</b>	87dB	87dB	90dB
<b>SPEAKER</b>	Woofer 100mm (4"), Tweeter 25mm (1")	Woofer 163mm (6½"), Tweeter 25mm (1")	Woofer 200mm (8"), Tweeter 25mm (1")
<b>DIMENSIONS (mm)</b>	W180 × H248 × D140	W215 × H310 × D175	W270 × H378 × D200
<b>WEIGHT</b>	2.45kg/2.92kg	3.22kg/3.80kg	4.97kg/6.30kg

Design and Specifications are subject to change without notice owing to continuous product up-gradation. Technical specifications are subject to production tolerances. We cannot be held responsible for printing errors, should they occur.

**AHUJA** is a registered trademark of Ahuja Radios in India and other countries. © Copyright Ahuja Radios, 2019. All rights reserved. Any unauthorized reproduction or use of logos, images or design elements is strictly prohibited by law.

No part of this compilation may be reproduced in any manner or translated without written permission.

---

### AHUJA RADIOS

E. & O. E. 0K/10/17

215, Okhla Industrial Estate, New Delhi-110020, INDIA

C-45, Phase-II, Noida-201305 (UP) INDIA

Tel.: +91-11-26831549, 41612474 Fax: +91-11-26847287

E-mail: [ahuja@ahujaradios.com](mailto:ahuja@ahujaradios.com) Website: [www.ahujaradios.com](http://www.ahujaradios.com)