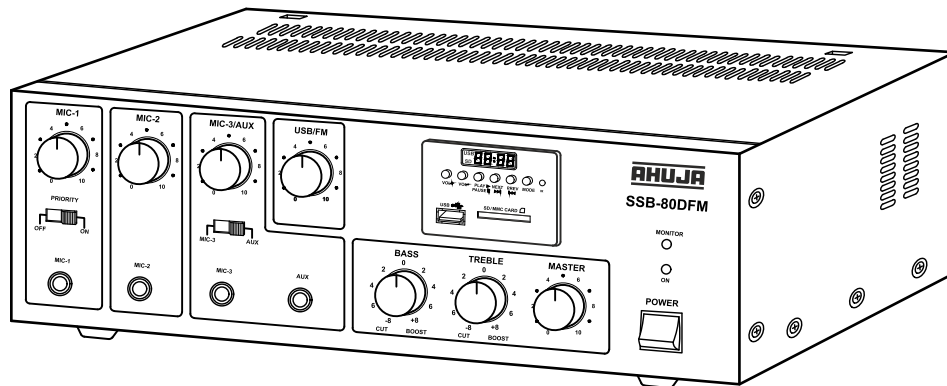

**AHUJA**<sup>®</sup>**PA Mixer Amplifier**

80W RMS/110W Max.

**SSB-80DFM**

- ◆ Thank you for purchasing the AHUJA PA Mixer Amplifier.
- ◆ Please read this manual thoroughly before making connections and turning on the power. Following the instructions in this manual will enable you to obtain optimum performance from your new AHUJA PA Mixer Amplifier.
- ◆ Please retain this manual for future reference.

## • Safety Instructions

**Read the Instructions:** Please read all the instructions in this section carefully before installation or use of the product. All the safety instructions must be followed.

**Retain the Instructions:** Please retain this Instruction Manual for future reference.



This symbol, wherever it appears, alerts you to the presence of uninsulated hazardous voltage that may be sufficient to constitute a risk of electric shock. External wiring to any terminal marked with this symbol must be done by a trained and instructed person only.



This symbol, wherever it appears adjacent to a component, alerts you that the concerned component can only be replaced by another of the exact same specifications.

### WARNING

- To reduce the risk of electric shock, do not remove the top cover. No user serviceable parts inside. Refer all servicing to qualified personnel only.
- Before replacing any fuse, make sure the set is switched off and disconnected from the AC mains or any other power source. Replace a fuse only with another of exactly same specification.

### CAUTIONS

**Water & Moisture:** To reduce the risk of fire or electrical shock, do not expose this set to rain or moisture. Do not use this set near water or in a wet location. Do not keep any object filled with liquid, such as a vase, on top of this set. Do not insert or remove the AC mains plug with wet hands.

**Power Source:** The voltage & frequency of the AC mains supply, and the voltage of the external battery, (if applicable) to which this set can be connected, is marked on the rear panel of the set. Do not connect this set to any power source other than those specified on the rear panel.

**Power Cord Protection:** Do not cut, kink, damage or modify the AC power cord supplied with this set. Keep the AC power cord away from heaters and harmful chemicals. Do not keep any heavy object on the power cord.

**Operation on Generator:** When operating this set on a generator, make sure the set is switched off till the generator voltage has stabilized.

**Ventilation:** This set should be situated so that its location or position does not interfere with its proper ventilation. Do not cover the ventilation holes / slots. Do not insert or drop anything into the ventilation holes / slots.

**Stability:** This set must be kept in a stable and flat horizontal position, and never in a tilted position. Do not place this set on an unstable stand, tripod, bracket or mount. Do not use attachments which are not supplied or explicitly recommended by the manufacturer.

**Cover Strip:** The cover strip of the 100V / 70V audio output terminal strip, and of any other high voltage output terminal strip, must be replaced after making connections. Failure to do so may result in exposure to hazardous voltages.

**Earthing:** This set must be earthed properly before use. A wire from the Earth terminal on the rear panel must be connected to electrical earth.

**Cleaning:** Disconnect this equipment from the AC mains and external battery before cleaning. Clean with a damp cloth, but do not allow any liquid to enter the set. Do not clean with liquids or aerosols.

**Exposure to Heat:** Do not touch the heatsinks while the set is working.

## • Table of Contents

<b>Contents</b>	<b>Page No.</b>
• <b>Features/General Description of Product</b> .....	<b>3</b>
• <b>Front/Rear Panel Controls &amp; Features</b> .....	<b>4</b>
• <b>MP3 Playback Facility: Controls &amp; Features</b> .....	<b>5</b>
• <b>Guideline for FM Tuning</b> .....	<b>6</b>
• <b>Interconnections</b> .....	<b>6</b>
• <b>Speaker Connections Guidelines</b> .....	<b>7</b>
• <b>Specifications</b> .....	<b>8</b>

## • Features/General Description of Product

- SSB-80DFM is a Mixer Amplifier with 80 watts rated power output.
- It has provision for priority on one mic input (MIC-1).
- The amplifier is provided with three Independent unbalanced Mic inputs, one Auxillary input and MP3 player with Bluetooth & FM.
- Preamp output for recording the program or connecting to Auxillary input of another Amplifier.
- Automatic changeover from AC to 12V battery operation, ensuring continuity of program.
- Protection against reverse polarity of battery connection.
- Ease of operation, combined with service accessibility has been optimized in the design.

## • Front/Rear Panel Controls & Features

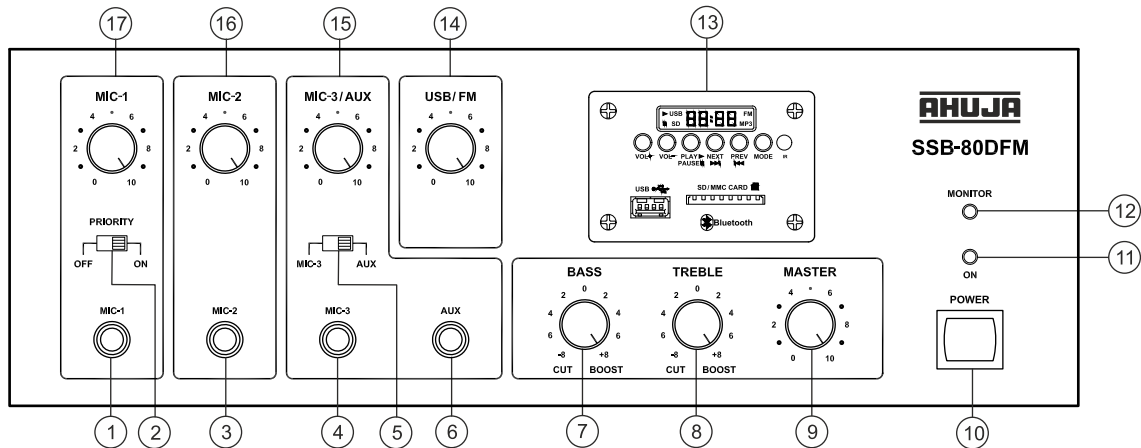

1. **MIC-1 Input Jack Socket:** For accepting unbalanced signal from a low impedance microphone.
2. **Priority Switch:** When switch is in ON position, MIC-1 has the priority over all other input.
3. **MIC-2 Input Jack Socket:** For accepting unbalanced signal from a low impedance microphone.
4. **MIC-3 Input Jack Socket:** For accepting unbalanced signal from a low impedance microphone.
5. **MIC-3 / AUX Selector Switch.**
6. **AUX Input Jack Socket:** For accepting unbalanced signal from an auxiliary source like CD player, USB player, Audio mixer etc.
7. **BASS Control:** For attenuating or boosting the signal level of low frequencies instruments like drum etc.
8. **TREBLE Control:** For attenuating or boosting the signal level of high frequencies musical instruments like guitar violin etc.
9. **MASTER Volume Control:** For adjustment of the overall volume level of Amplifier.
10. **POWER Switch:** Push the top part of the knob to switch the amplifier ON. Push the bottom part of the knob to switch the amplifier OFF.
11. **POWER LED:** This glows when the amplifier is switched ON.
12. **MONITOR LED:** This indicates the output level.
13. **MP3 module with Bluetooth & FM** (See on Page no.5).
14. **USB/FM Volume centre**
15. **MIC-3 / AUX Volume Control**
16. **MIC-2 Volume Control**
17. **MIC-1 Volume Control**

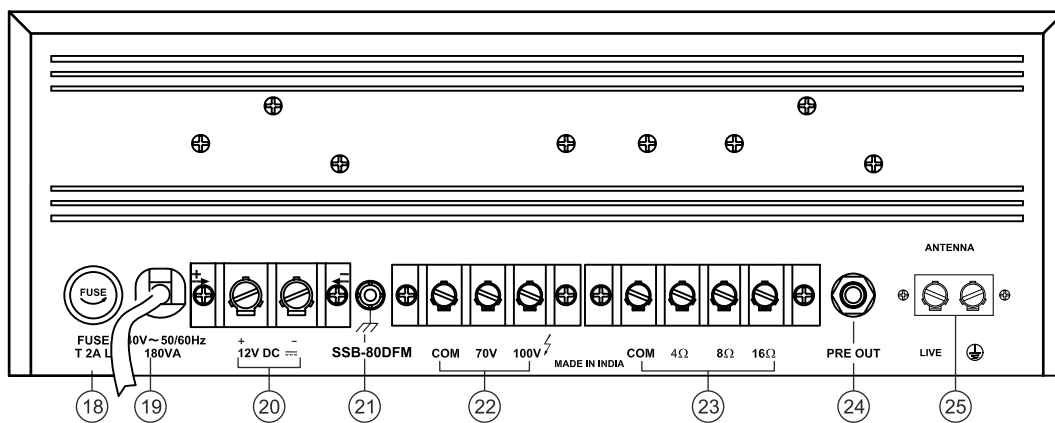

18. **AC MAINS FUSE Rating 2 AMP 250V (T 2A L)**  
This protects the amplifier from any excessive current flow. In case the fuse fails, replace with another of exact same rating.
19. **3 CORE AC MAINS CABLE With Plug**
20. **BATTERY Terminal Block**  
For connecting 12V Car Battery as standby power source.
21. **EARTH Terminal**
22. **SPEAKER Terminal Block (70V, 100V)**  
For connecting speakers with 100V line matching transformers.
23. **SPEAKER Terminal Block (4ohms, 8 ohms and 16 ohms)**  
For connecting low impedance speakers.
24. **PRE AMPLIFIER Output Jack Socket**  
For connecting to the AUX input of another amplifier or a recorder for recording purpose.
25. **Antenna Terminal**  
For connecting Antenna, wire for FM.

## • MP3 Playback Facility: Controls & Features

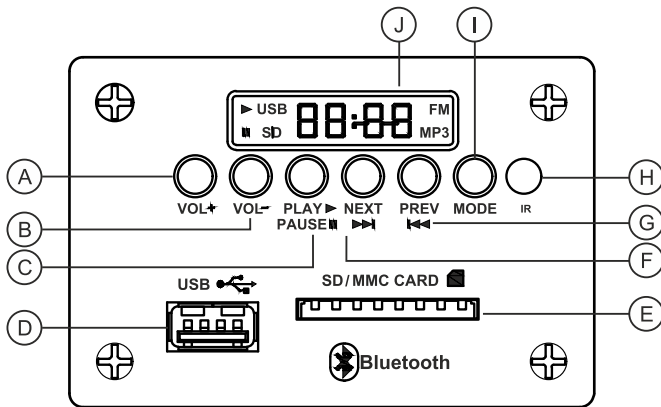

### Remote Control

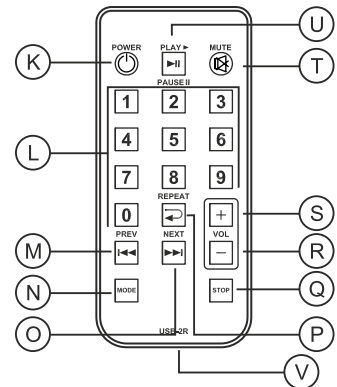

- A. **VOL+** : To increase volume level of MP3 player.
- B. **VOL-** : To decrease volume level of MP3 player.
- C. **▶|| PLAY/PAUSE**: When Mode is selected to either USB or Bluetooth Press PLAY/PAUSE once to Pause if music is already playing. Press PLAY/PAUSE again to resume playing. When Mode is selected to FM, this key is used to select manual or Auto tuning.
- D. **USB Connector**: Insert the USB drive here. While inserting USB drive into the USB connector, hold the USB drive in such a way that hollow part of the USB drive is downwards as shown in Figure.

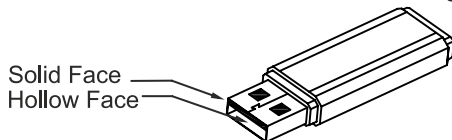

Any forceful insertion in wrong direction will damage the connector.

- E. **SD/MMC Card Connector**: Insert the SD/MMC Card into the slot to play. When taking out the card, push the card to take out.

While inserting SD/MMC card into the slot, ensure that the card is inserted in such a way that all pins are facing upward and cut is towards left as shown in figure.

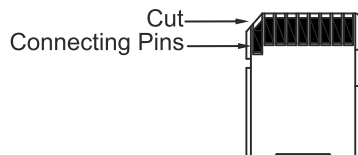

- F. **▶▶ Next**: Press NEXT to select next forward music track. Pressing NEXT repeatedly will move the system to successively next forward tracks. Then press PLAY/PAUSE for playing the track so selected.
- G. **◀◀ Prev**: Press PREV to Select the previous track. Pressing PREV repeatedly will move the system to successively previous tracks.
- H. **IR Sensor**: Picks up signal from the Remote

- I. **Mode**: To select USB, SD or Bluetooth when USB SD both are inserted. Default condition the set is USB Mode.
- J. **LED Display**: Instantly displays 3 digits of the track selected play to i.e 001 to 999. During play, display the time duration of the track played.

### Remote Control

- K. **Power**: Press once to switch off MP3 player, press again to switch ON.
- L. Number key 0 to 9. To choose the track number or FM Stations to be played.
- M. **◀◀**: To select the previous track or FM Stations.
- N. **MODE** : To select SD or USB bluetooth or FM.
- O. **▶▶**: Press to select the next track or FM Station.
- P. **↺** Press once to repeat the song being played. Press twice to repeat all the songs.
- Q. **STOP**: Press to stop the track being played.
- R. **Vol-**: Press to decrease the volume of MP3 Player.
- S. **Vol+**: Press to increase the volume of MP3 Player.
- T. **MUTE**: Press once to mute the sound, press again the resume the sound.
- U. **▶|| PLAY/PAUSE**: When mode is USB/Bluetooth Press Play/Pause once to Pause when music is already playing. Press Play/Pause again to resume playing. When mode is FM than this key is used for setting if manual or Auto tuning.
- V. **Battery Replacement**: Pull out the battery tray and replace the battery with positive electrode facing upwards as shown in fig. below. Push the battery compartment back to the close position. Use CR2025 or equivalent lithium coin cell.

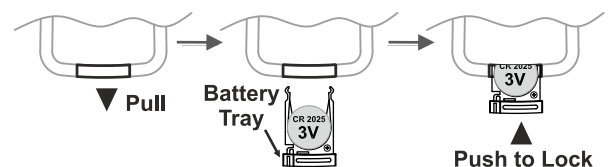

## • **Guideline for FM Tuning**

1. Press Mode switch on the USB Module to select FM.
2. For Auto Tuning, long press the Play/Pause key and the module will be in Auto Tune mode. All available stations will automatically get tuned and saved to the program locations P1,P2,P3... etc.
3. For Manual Tuning, short press Play/Pause key. The display LED will start blinking. Now Press Prev. or Next key to tune the desired station.
4. To save this station, press Play/Pause key again while the display LED is still blinking. The station will be saved to the next unassigned program.
5. If we feed the FM frequency of the desired station by pressing the numeric keys of the Remote control, it will play the desired station. For example to play 104.0 MHz, feed 1040 on the Remote control. The station 104.0 MHz will be displayed and start playing. However this station will not be saved automatically. Follow steps 3&4 to save the desired station.
6. To access the saved stations, press Next or Prev. key on the module.
7. We can also press numeric keys 1,2,3... etc. on Remote control for retrieving the FM station saved in program locations P1,P2,P3... etc.

## • **Interconnections**

- The amplifier can be placed as a table top unit. The amplifier should be situated so that its location or position does not interfere with its proper ventilation.
- The amplifier must be powered through an earthed AC mains outlet (or external 12V car battery).
- All connections must only be carried out or changed with the amplifier switched OFF.
- To avoid loud switching noise, always switch ON the amplifier after all other units of the audio system (like Mixer, if connected) have been switched ON. After operation switch the amplifier OFF first and then the other units.
- The connection diagrams that follow display the typical types of input sources (Mics, Keyboard, MP3 Player, Mixer, CD Player etc.) and speakers (Wall, Ceiling, Box, Horn, Column) which can be connected to the amplifier. For correct connections and operation check the specifications of the connected equipment.

### **CAUTION**

- The equipment must be earthed properly before operating it to avoid electric shock. A wire from the Earth Terminal must be connected to electrical earth for safe operation.

## • Speaker Connection Guidelines

SSB-80DFM is a medium power PA Mixer amplifier. Therefore it is very important that correct loudspeaker connections are made to avoid damage to the amplifier or speakers.

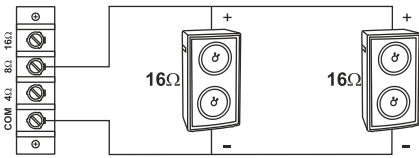
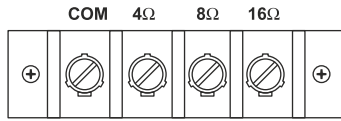

Resultant Impedance =  $16/2 = 8\text{ ohms}$

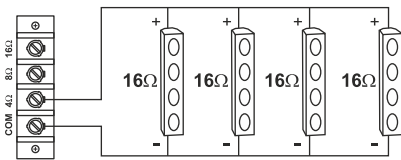

Resultant Impedance =  $16/4 = 4\text{ ohms}$

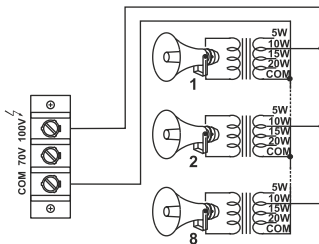
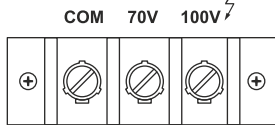

### Low Impedance Speaker Connections

- Box Type Speakers like SRX-50DX can be directly connected to COM - 4Ω / 8Ω / 16Ω Terminal Strip.
- Driver Units without Line Matching Transformers like AU-35 / AU-40 / AU-60 can be directly connected to COM - 4Ω / 8Ω / 16Ω Terminal Strip.
- Column Speaker without Line Matching Transformers like SCM-15 / SCM-30 can be directly connected to COM - 4Ω / 8Ω / 16Ω Terminal Strip.
- Make sure that the total power handling capacity of the connected speakers is NOT less than the rated power of the amplifier, namely 80 watts.

### Connecting Two SRX-50DX Speakers

- The Two loudspeakers should be wired in parallel as shown in figure. The resulting impedance of the speaker system is 8Ω . Thus they should be connected to the 8Ω Tap of the amplifier.

### Connecting Four SCM-30 Speakers

- The four column speakers should be connected in parallel. The resulting impedance would be 4Ω. Thus they should be connected to the 4Ω Tap of the amplifier.

### High Impedance Speakers or Speakers Using A 100V

#### Line Matching Transformer

- Driver Units / Horn Speakers / Column Speakers with 100V Line Matching Transformers are only to be connected to COM - 70V / 100V Terminal Strip.
- When any of the above speakers are connected to the COM - 70V / 100V Terminal Strip then NO speakers should be connected to the COM - 4Ω / 8Ω / 16Ω Terminal Strip.
- The power drawn from the amplifier should not exceed 80 Watts. In other words, the power rating of all the speakers put on 100V or 70V tap should not exceed 80W.

### Connecting Eight Driver Units with 100V LMT

- 8 Driver Units with 100V Line Matching Transformer connected at 10 Watts tap can be operated.

### Use of 70 Volt Line

- A loudspeaker with its LMT adjusted to the 10W tap, when connected to COM and 100V terminals on the amplifier's Terminal Strip will draw 10W from the amplifier but when the same is connected to COM and 70V it will only draw half power i.e. 5W. A good use of 70V line tap can be made in installations where large number of speakers/ driver units are to be installed for more even distribution of sound

### Correct Phasing of Loudspeakers

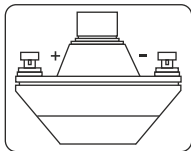

- When two or more Speakers / Units are installed in the same area and are facing the same direction, it is essential that their cones/diaphragms act in unison. Otherwise the sound level of one speaker will be canceling the sound level of the other. To avoid any mistake, the terminals of Box Speakers and the Driver Units are marked '+' & '-'. Always connect the COM of the Amplifier to '-' of speaker & 4Ω/8Ω/16Ω of the amplifier to the '+' of the speakers.
- In case of LMTs the COM of all the LMTs should be connected to the COM of the red strip terminal of the amplifier and the power tap to 100V line as shown in figure.

### IMPORTANT

- When speakers are connected to COM - 4Ω / 8Ω / 16Ω Terminal Strip NO speakers should be connected to the Red Terminal Strip marked COM - 70V / 100V.
- Speakers should be connected only to either COM - 4Ω or COM - 8Ω or COM - 16Ω terminals as illustrated above but never to more than one set of terminals.
- When 70 / 100 Volt line is being used, no speakers / driver units should be connected to 4Ω / 8Ω / 16Ω (Low Impedance) Tap.
- Loudspeaker / driver unit should be connected to either COM - 100V or COM - 70V terminals, but never to more than one set of terminals.

## • Specifications

<b>Model</b>	<b>SSB-80DFM</b>
<b>Power Output</b>	110W RMS Max. 80W RMS at 10% THD 75W RMS at 5% THD 60W RMS at 2% THD
<b>Output Regulation</b>	≤ 2dB no load to full load at 1kHz
<b>Input Channels</b>	3 × Mic. 0.85mV / 4.7kΩ (Mic source impedance 50Ω to 1kΩ) 1 × Aux. 100mV / 470kΩ
<b>Frequency Response</b>	65 – 15000 Hz ±3dB
<b>Signal to Noise Ratio</b>	60dB
<b>Tone Controls</b>	Bass: ± 8dB at 100Hz Treble: ± 8dB at 10kHz
<b>Pre-amp Output</b>	200mV / 600Ω
<b>Output Taps For Speaker Matching</b>	4Ω, 8Ω & 16Ω (for direct connections) 70 & 100V Line (for use with LMT)
<b>Power Supply</b>	AC: 220 - 240V 50 / 60Hz (110V on request); DC: 12V (Car Battery)
<b>Protection</b>	AC: Fuse 2Amp. (T 2AL); DC: Fuse 10Amp. (T 10AL)
<b>AC Power Consumption</b>	180VA
<b>DC Power Consumption</b>	3A (average)
<b>Dimensions</b>	W355 x H133 x D285 mm
<b>Weight</b>	8.43 kg approx.

**AHUJA RADIOS** • 215, Okhla Industrial Estate, New Delhi - 110 020, INDIA  
Tel.: +91-11-26831549, 41612474 Fax : +91-11-26847287  
E-mail : ahuja@ahujaradios.com, admin@ahujaradios.com  
Website: www.ahujaradios.com

- Design and Specifications are subject to change without notice owing to continuous product up-gradation
- Technical specifications are subject to production tolerances.
- We cannot be held responsible for printing errors, should they occur.
- **AHUJA** is a registered trademark of Ahuja Radios in India and other countries.
- © Copyright Ahuja Radios, 2018. All rights reserved. Any unauthorized reproduction or use of logos, images or design elements is strictly prohibited by law.
- No part of this compilation may be reproduced in any manner or translated without written permission.

