

AHUJA®

Dual Channel Power Amplifier

2250W + 2250W RMS

OPERATION MANUAL

LXA-4500

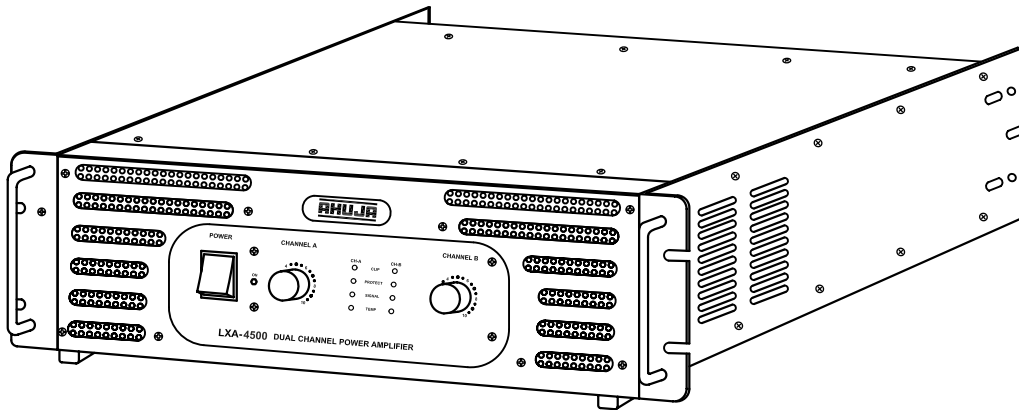

- ◆ Thank you for purchasing the AHUJA Direct Coupled Amplifier.
- ◆ Please read this manual thoroughly before making connections and turning on the power. Following the instructions in this manual will enable you to obtain optimum performance from your new AHUJA Direct Coupled Amplifier.
- ◆ Please retain this manual for future reference.

• Safety Instructions

Read the Instructions: Please read all the instructions in this section carefully before installation or use of the product. All the safety instructions must be followed.

Retain the Instructions: Please retain this Instruction Manual for future reference.



This symbol, wherever it appears, alerts you to the presence of uninsulated hazardous voltage that may be sufficient to constitute a risk of electric shock. External wiring to any terminal marked with this symbol must be done by a trained and instructed person only.



This symbol, wherever it appears adjacent to a component, alerts you that the concerned component can only be replaced by another of the exact same specifications.

WARNING

- To reduce the risk of electric shock, do not remove the top cover. No user serviceable parts inside. Refer all servicing to qualified personnel only.
- Before replacing any fuse, make sure the set is switched off and disconnected from the AC mains or any other power source. Replace a fuse only with another of exactly same specification.

CAUTIONS

Water & Moisture: To reduce the risk of fire or electrical shock, do not expose this set to rain or moisture. Do not use this set near water or in a wet location. Do not keep any object filled with liquid, such as a vase, on top of this set. Do not insert or remove the AC mains plug with wet hands.

Power Source: The voltage & frequency of the AC mains supply, to which this set can be connected, is marked on the rear panel of the set. Do not connect this set to any power source other than those specified on the rear panel.

Power Cord Protection: Do not cut, kink, damage or modify the AC power cord supplied with this set. Keep the AC power cord away from heaters and harmful chemicals. Do not keep any heavy object on the power cord.

Operation on Generator: When operating this set on a generator, make sure the set is switched off till the generator voltage has stabilized.

Ventilation: This set should be situated so that its location or position does not interfere with its proper ventilation. Do not cover the ventilation holes / slots. Do not insert or drop anything into the ventilation holes / slots.

Stability: This set must be kept in a stable and flat horizontal position, and never in a tilted position. Do not place this set on an unstable stand, tripod, bracket or mount. Do not use attachments which are not supplied or explicitly recommended by the manufacturer.

Earthing: This set must be earthed properly before use. A wire from the Earth terminal on the rear panel must be connected to electrical earth.

Cleaning: Disconnect this equipment from the AC mains and external battery before cleaning. Clean with a damp cloth, but do not allow any liquid to enter the set. Do not clean with liquids or aerosols.

• Table of Contents

Contents	Page No.
• Features/General Description of Product	4
• Front Panel Controls & Features	5
• Rear Panel Controls & Features	6
• Input - Output Connections	7
• Setup & Operations	8
• Tips for Safe Operation	10
• Typical Applications	11
• Protections & Installations	13
• Trouble Shooting	14
• Specifications	16

• Features/General Description of Product

- Rugged 19" rack mountable chassis.
- Heavy duty high current toroidal transformer which provides excellent regulation and minimises hum & noise.
- Low distortion and high damping factor for excellent sound quality.
- Extensive protection circuit for Temperature (transistor and transformer), Overload, Over voltage, DC, RFI and Output short circuit. The amplifier is protected for variations in AC supply (due to Genset / AC Mains fluctuation) up to 300V.
- Indicator LEDs for Signal, Clip, Temperature (output devices and transformer), Protect mode conditions.
- Output termination on Dual Connectors (Speakon 4-way & Binding Post) for each channel.
- Built in limiter circuit, which protects the amplifier and speaker from being over driven because of high input level signal.
- Balanced / Unbalanced input signal through parallel XLR and 6.3mm (1/4") stereo phone jack in both channels.
- Slide switch selection of Mono / Stereo / Bridge Mode provided on rear panel.
- Switchable ground lift to break the unwanted ground loops.
- Low pass filter switchable to 80Hz & 120 Hz to use for subwoofer applications.
- Limiter On/Off switch.

• Front Panel Controls & Features

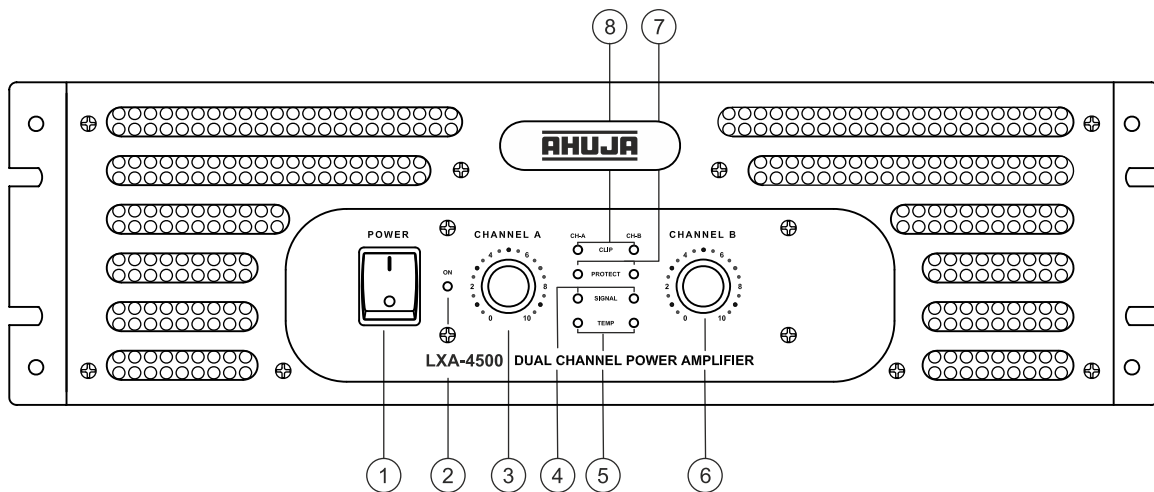

1. POWER Switch

Push the top part of the knob (marked I) to switch the amplifier ON. Push the bottom part of the knob (marked O) to switch the amplifier OFF.

2. Power LED

This LED glows when the amplifier is switched ON.

3. Volume Control for Channel A

When used in Stereo/Mono mode, it adjusts the volume level of channel A. While in Bridge mode, it adjusts the volume level of both the channels A & B connected in Bridge mode.

4. Signal Indicator LEDs for Channel A & B

Indicate the presence of signal in channel A and B respectively.

5. Temperature Indicator LEDs for Channel A & B

Separate yellow LEDs provided for each of the two channels A & B. Glowing of these LEDs indicates excessive temperature of the output devices or transformer. The special circuitry then mutes the input signals. The amplifier will remain at mute status, till the devices cool down to normal temperature. Switch OFF the amplifier to cool down and then switch ON to continue.

6. Volume Control for Channel B

To be used only in Stereo/Mono mode for adjusting the volume level of channel B. This control is inactive in Bridge mode.

7. Protect Indicator LEDs for Channel A & B

Separate orange LED provided for each of the two channels A & B. These LED's glow when the output is shorted or the output is overloaded or the input is too high or DC voltage is present on the speaker output. In any of these conditions the amplifier goes to protect mode. To reset the amplifier, switch OFF the amplifier, turn volume control to zero, correct the fault, and switch ON the amplifier after 5-10 seconds. Increase the volume control slowly to the desired output below Clip level.

8. CLIP Level LEDs for Channel A & B

One separate red LED provided for each channel. Continuous glow of LEDs indicates that there is excessive signal being fed to the input of the amplifier resulting in clipped and distorted output levels. In such cases, it is advisable to reduce the input signal or reduce the volume setting. Otherwise, the amplifier may go into protect mode and signal will mute.

• Rear Panel Controls & Features

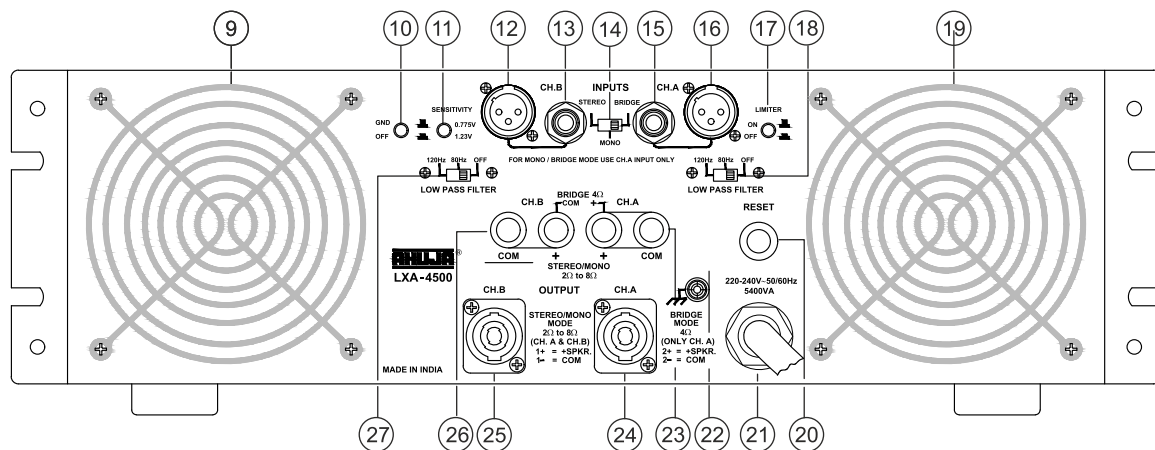

9. Fan Grill

Protective grill for channel B fan. Do not insert anything into this opening.

10. Ground Lift:

Ground loop form when multiple sets are used, which can cause Hum. Using this switch can improve hum & noise by breaking unwanted ground loops.

11. Sensitivity Selector Switch:

Push switch to select the input sensitivity between 0.775V & 1.23V. It is suggested to use 1.23V sensitivity if programme signal is fed from a mixer. The pushed in (pressed) position of the switch is for 1.23V sensitivity.

12. XLR INPUT for Channel B:

This XLR connector takes the balanced / unbalanced signals for driving channel B. Inputs can be wired as per fig. 1 & 2 (*Input Connections for Balanced and Unbalanced Mode*).

13. 6.3 mm (1/4") Jack Input for Channel B:

The stereo jack connector accepts the balanced / unbalanced signals to drive the channel B. Inputs can be wired as per fig. 1 & 2 (*Input Connections for Balanced and Unbalanced Mode*).

14. STEREO / MONO / BRIDGE Mode Selector Switch:

This slide switch is used to operate the unit in stereo, mono or bridge mode.

15. 6.3 mm (1/4") Jack Input for Channel A:

The stereo jack connector accepts the balanced / unbalanced signals to drive the channel A when used in stereo mode and channel A & B when used in mono and bridge mode operation. Inputs can be wired as per fig. 1 & 2 (*Input Connections for Balanced and Unbalanced Mode*).

16. XLR INPUT for Channel A:

This XLR connector accepts the balanced / unbalanced signals to drive the channel A in stereo mode and channel A & B if used in mono and bridge mode operation. Inputs can be wired as per fig. 1 & 2 (*Input Connections for Balanced and Unbalanced Mode*).

17. LIMITER ON/OFF Switch:

Limiter is active when switch is unpressed. It is advised to use the Limiter On in normal operations.

Whenever it is used for limiter OFF, drive the amplifier for controlled output to protect the speakers from failure.

18. Low Pass Filter for Channel A:

Select the frequencies to 80Hz or 120Hz to use amplifier to drive sub woofers. When switch is OFF, the amplifier will be working for full audio frequency spectrum.

19. Fan Grill:

Protective grill for channel A fan. Do not insert anything into this opening.

20. △ AC Mains CKT Protector (Rating 25 AMP):

This protects the amplifier from any excessive current flow and trips when over loaded or in fault conditions.

21. 3 Core AC Mains Cable with Plug

22. Earth Terminal: For earthing the chassis.

23. Binding Post Terminal for Channel A Output:

This output terminal is parallel to Pin 1+ & 1- of speakon connector of channel A and may be used when speakon plugs are not available.

24. Speakon Connector for Channel A Output:

In STEREO / MONO mode amplified signal is available at Pin 1+ & 1- of speakon connector. The output speakon connectors should be wired as per fig. 3 (*Output Connectors for Stereo / Mono Mode*). In BRIDGE mode the output is taken from Pin 2+ and 2- of speakon connector. Output speakon connectors to be wired as per fig. 4 (*Output Connections for Bridge Mode*).

25. Speakon Connector for Channel B Output

Amplified signal is available at Pin 1+ & 1- of speakon connector. The output speakon connectors should be wired as per fig. 3 (*Output Connectors for Stereo / Mono Mode*). This is not used in Bridge mode.

26. Binding Post Terminal for Channel B Output:

This output terminal is parallel to Pin 1+ & 1- of speakon connector of channel B.

27. Low Pass Filter for Channel B:

Select the frequencies to 80Hz or 120Hz to use amplifier to drive sub woofers. When switch is OFF, the amplifier will be working for full audio frequency spectrum.

• Input - Output Connections

Fig. 1 Input Connections - Balanced Mode

3 Pin Male XLR

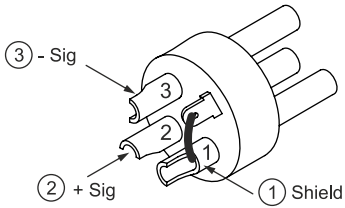

6.3 mm (1/4") Stereo Phone Plug

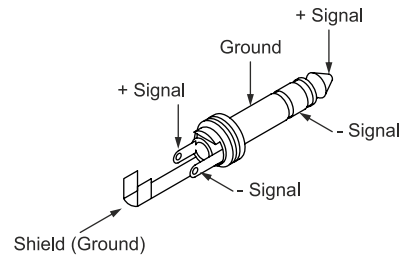
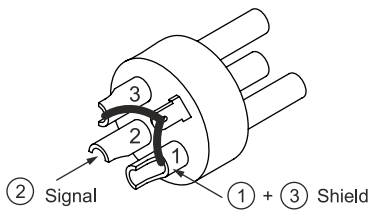

Fig. 2 Input Connections - Unbalanced Mode

3 Pin Male XLR



6.3 mm (1/4") Mono Phone Plug

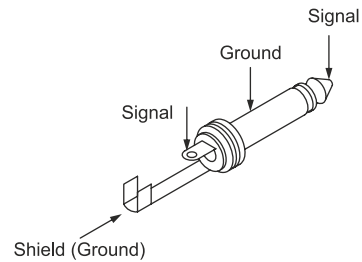
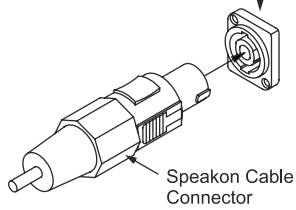
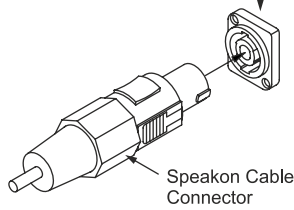

Fig. 3 Output Connections - Stereo / Mono Mode

Output Channel A



Output Channel B



Speakon Cable Connector (Inside View)

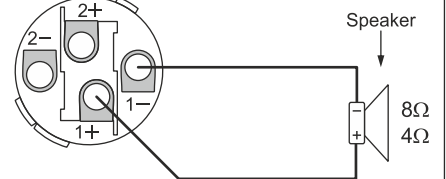
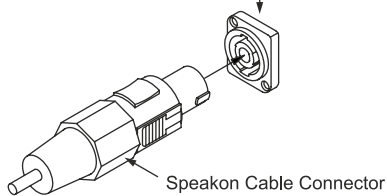
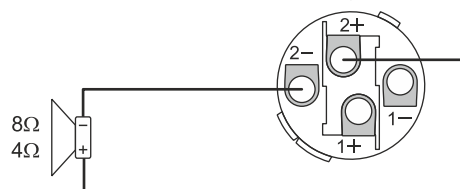

Fig. 4 Output Connections - Bridge Mode

Output Channel A



Speakon Cable Connector (Inside View)



• Setup & Operations

Stereo Mode Configuration

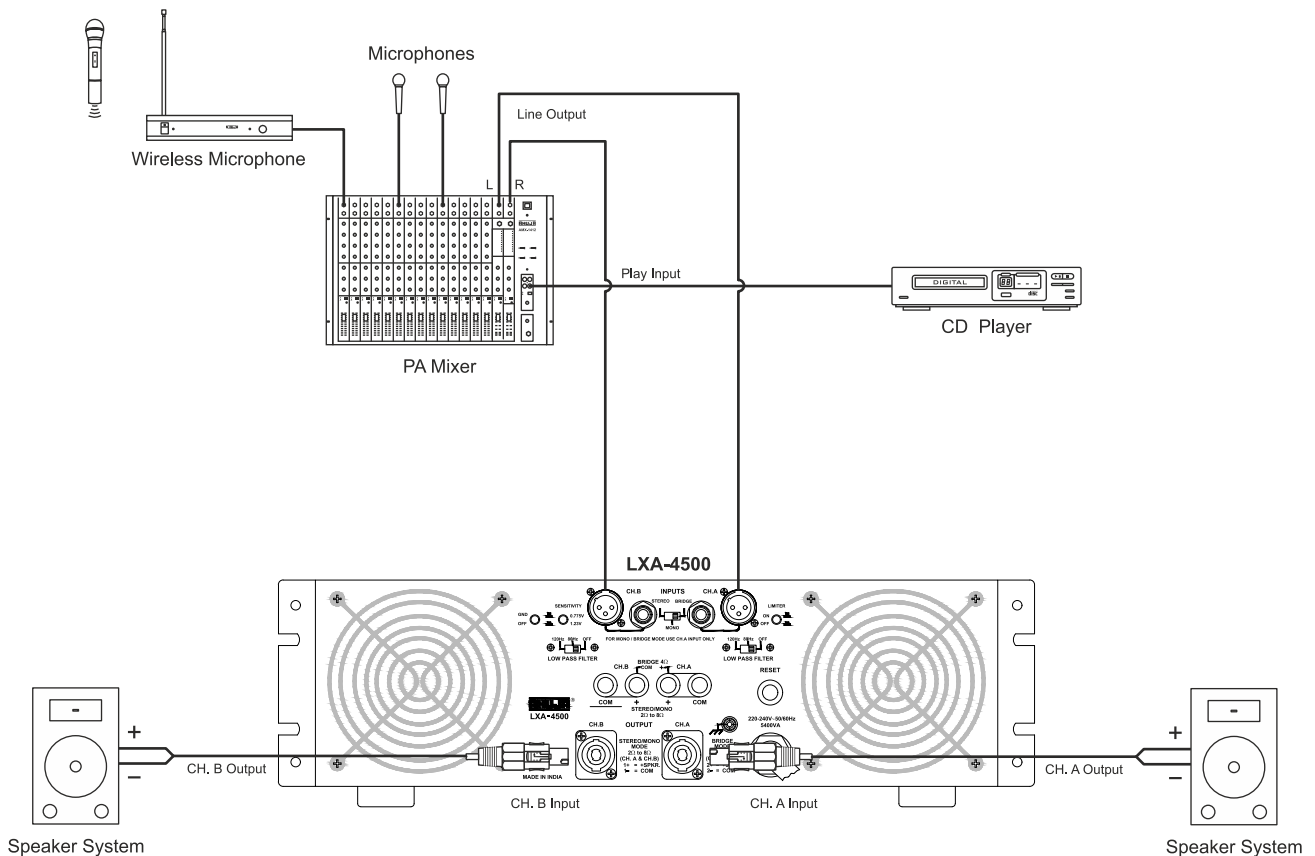

In STEREO mode, both channels A & B are fully independent of each other. The balanced / unbalanced inputs can be connected either to a stereo signal source or two independent mono signal sources. Each channel can separately drive loudspeaker loads of 8/4/2 ohms.

- Connect the Left and Right outputs of a mixer to channel A and B inputs of the amplifier respectively. Inputs can be wired as per fig. 1 & 2 (*Input Connections for Balanced and Unbalanced Mode*).
- Connect a speaker system on the output terminal of each channel. It is recommended to use the speakon connectors and wire these as per fig. 3 (*Output Connections for Stereo / Mono Mode*).
- To select STEREO mode, keep the slide switch, provided at rear panel, in STEREO position.
- Adjust the individual volume controls of each channel on the front panel to obtain the desired output level.
- The signal indicator LEDs glow to indicate the presence of signal at the output terminals.
- Adjust the input signal level below the threshold of clip LED glow.

Mono Mode Configuration

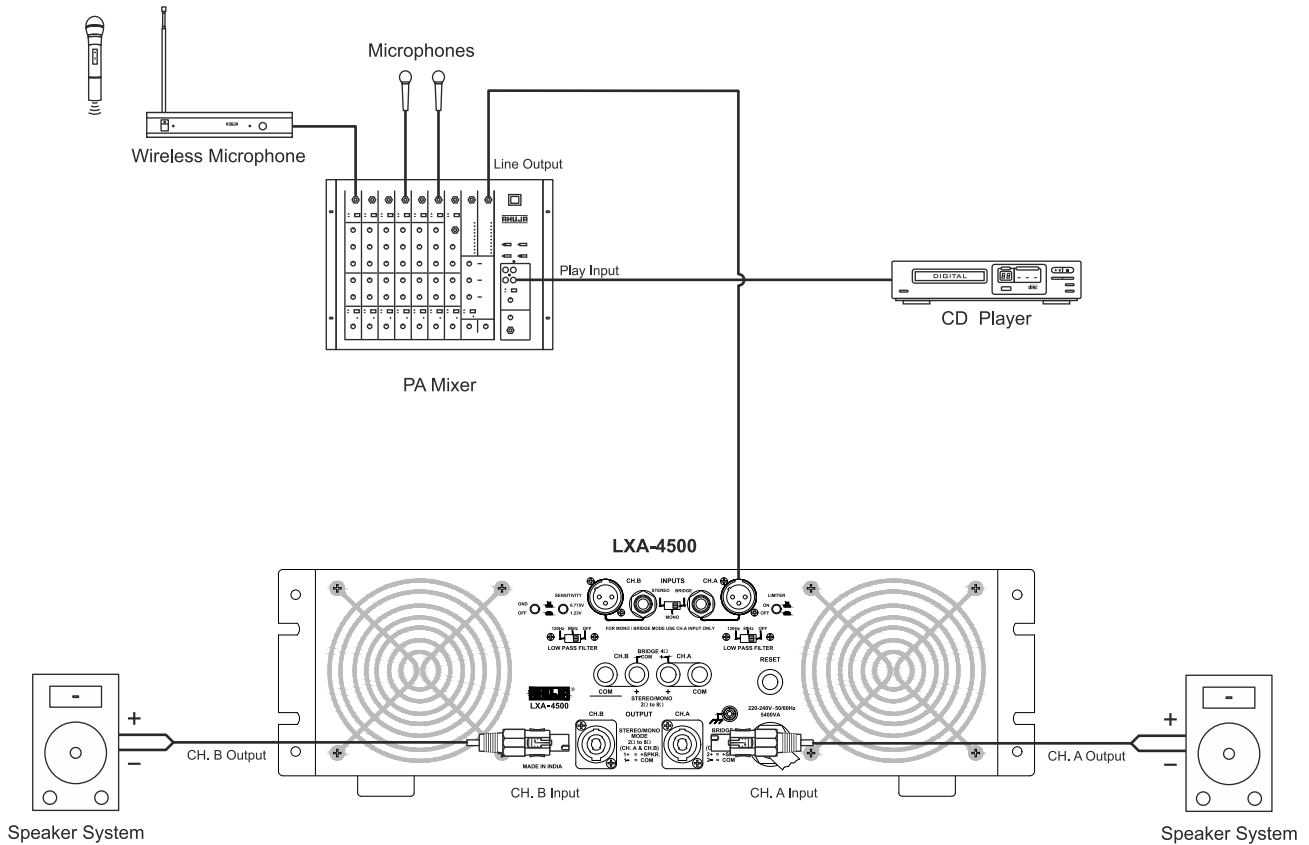

When operating in MONO mode, the signal source should be connected to the balanced / unbalanced input of **channel A only**. Both channels provide similar output to their respective loudspeakers. Each channel can separately drive loudspeaker loads of 8/4/2 ohms.

- Connect the line output of a mixer to channel A input of the amplifier. Input can be wired as per fig. 1 & 2 (*Input Connections for Balanced and Unbalanced Mode*).
- Connect a speaker system on the output terminal of each channel. It is recommended to use the speakon connectors and wire these as per fig. 3 (*Output Connections for Stereo / Mono Mode*).
- To select MONO mode, keep the slide switch, provided at rear panel, in MONO position.
- The desired output levels of the A & B channels are adjustable by individual control of channel A & B respectively.
- The signal indicator LEDs glow to indicate the presence of signal.
- Operate the amplifier below the onset of clip LED glow. Continuous clip LED glow may push amplifier into protect mode.

Bridge Mode Configuration

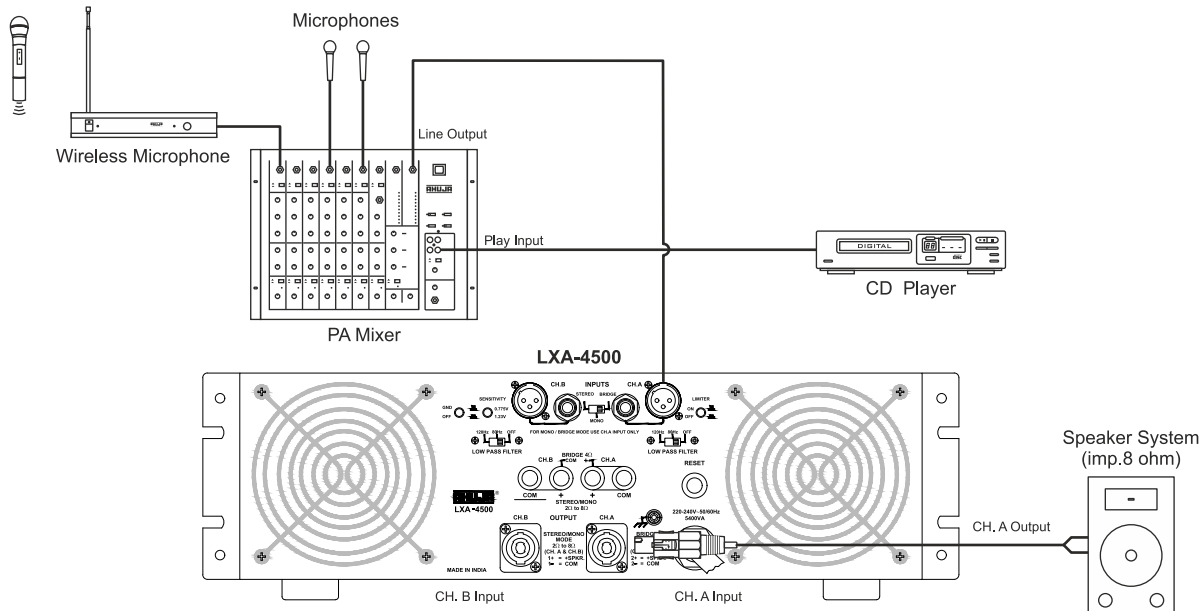

For BRIDGE mode operation, the signal source should be connected to the balanced / unbalanced input of **channel A only**. This mode provides the combined power output of both channels for connecting a single loudspeaker load. The recommended combined loudspeaker load should be 8 ohm.

- Connect the line output of a mixer to channel A input of the amplifier. Input can be wired as per fig. 1 & 2 (*Input Connections for Balanced and Unbalanced Mode*).
- Connect a speaker system (not below 4 ohm) on the speaker output of channel A only. It is recommended to use the speakon connectors and wire these as per fig. 4 (*Output Connections for Bridge Mode*).
- If however binding posts are to be used for bridge mode then connect the positive (+) of the loudspeaker to the positive (+) (Red) terminal of binding posts for channel A and the negative (-) of the loudspeaker to the positive (+) Red terminal of Binding Post of channel B.
- To select bridge mode, keep the slide switch, provided at rear, in BRIDGE position.
- The desired output levels of both the channels are adjustable by volume control of channel A only.
- The signal indicator LEDs glow to indicate the presence of signal at the output terminals.
- Operate the amplifier below the clip LED glow.



Tips for Safe Operation

- The amplifier must be connected to an AC earthed mains outlet that can deliver the maximum power required. The use of extension cables or adaptors should be avoided as this can jeopardize correct current delivery to the amplifier.
- All connections must only be carried out or changed with the amplifier switched OFF & the AC mains supply disconnected.
- Ensure proper impedance matching. For continuous safe operation, resultant impedance of the speakers **is recommended as 8 ohm** in bridge mode and 4 or 8 ohms in mono/stereo modes.
- For 4 ohm applications, it is recommended to use speakon connectors only.
- Use of cable 40 / 36 or thicker is recommended to prevent power losses in speaker cables.
- The level of input signal should not exceed the specified input sensitivities. Excessive input signal levels result in over driving of input circuit which leads to saturated / distorted output at speaker terminals.
- Do not operate the amplifier with continuously glowing CLIP LED. The respective volume control of the channels must be adjusted so that the output level does not clip and distort.
- Do not obstruct the front or rear of the amplifier for necessary intake of air. This is a fan cooled amplifier.

Stereo Mix Plus Subwoofers (LXA-2400 with LXA-4500)

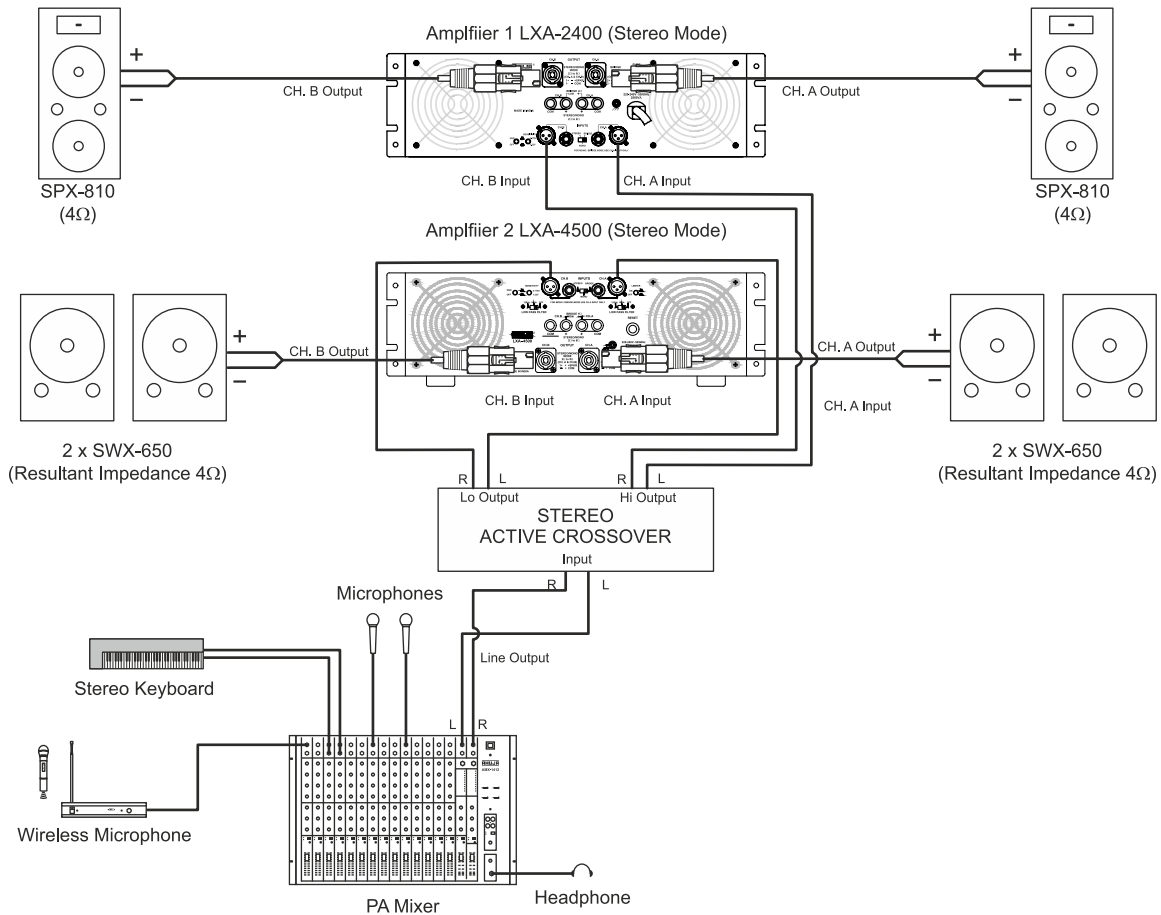

- Connect the Left and Right outputs of the Audio mixing console to the respective inputs of the Active Crossover.
- Connect the Left and Right High frequency output of the active crossover to the respective input channels A & B of amplifier 1 (LXA-2400). Inputs can be wired as per fig. 1 & 2 (*Input Connections for Balanced and Unbalanced Mode*).
- One number of full range loudspeaker system SPX-810 can be connected to each of the output channels of amplifier 1. The output speakon connectors should be wired as per fig. 3 (*Output Connections for Stereo / Mono Mode*).
- Amplifier 1 will be used in stereo mode. Keep the slide switch of amplifier 1 in stereo position.
- Feed the left Low frequency output signal of the crossover to the channel A input of amplifier 2 (LXA-4500). Similarly feed the Right Low frequency output signal of the crossover to the channel B input of amplifier 2 (LXA-4500). Inputs can be wired as per fig. 1 & 2 (*Input Connections for Balanced and Unbalanced Mode*).
- Two no. of subwoofer system SWX-650 (in parallel), can be connected to the channel A output of Amplifier2.

Similarly connect two no. of subwoofer to system SWX-650 (in parallel), can be connected B outputs of amplifiers 2 respectively. Output speakon connectors to be wired as per fig. 4 (*Output Connections for Stereo Mode*).

- The speakon is the preferred choice for connections, but if the output connections are to be made on binding posts for stereo mode applications, then (+) of the speaker should be wired on (+) (Red) terminal of channel A output and (-) of the speaker should be wired on (-) (Black) terminal of the channel A output.
- Amplifier 2 will be used in stereo mode. Keep the slide switch of amplifier 2 STEREO position to activate stereo mode.
- Finally adjust the volume control of channel A & B in amplifier 1 (LXA-2400) to control the level of their respective SPX-810.
- Also, adjust the volume control of channel A & B in amplifier 2 (LXA-4500) to control the levels of their respective SWX-650 stacks.
- Operate the amplifier in such a way the clip LED should not blink continuously.
- Continuously clip LED glow may bring amplifier into protect mode.

• Typical Applications...

Stereo Line Array Applications (Using LXA-6000 & LXA-4500)

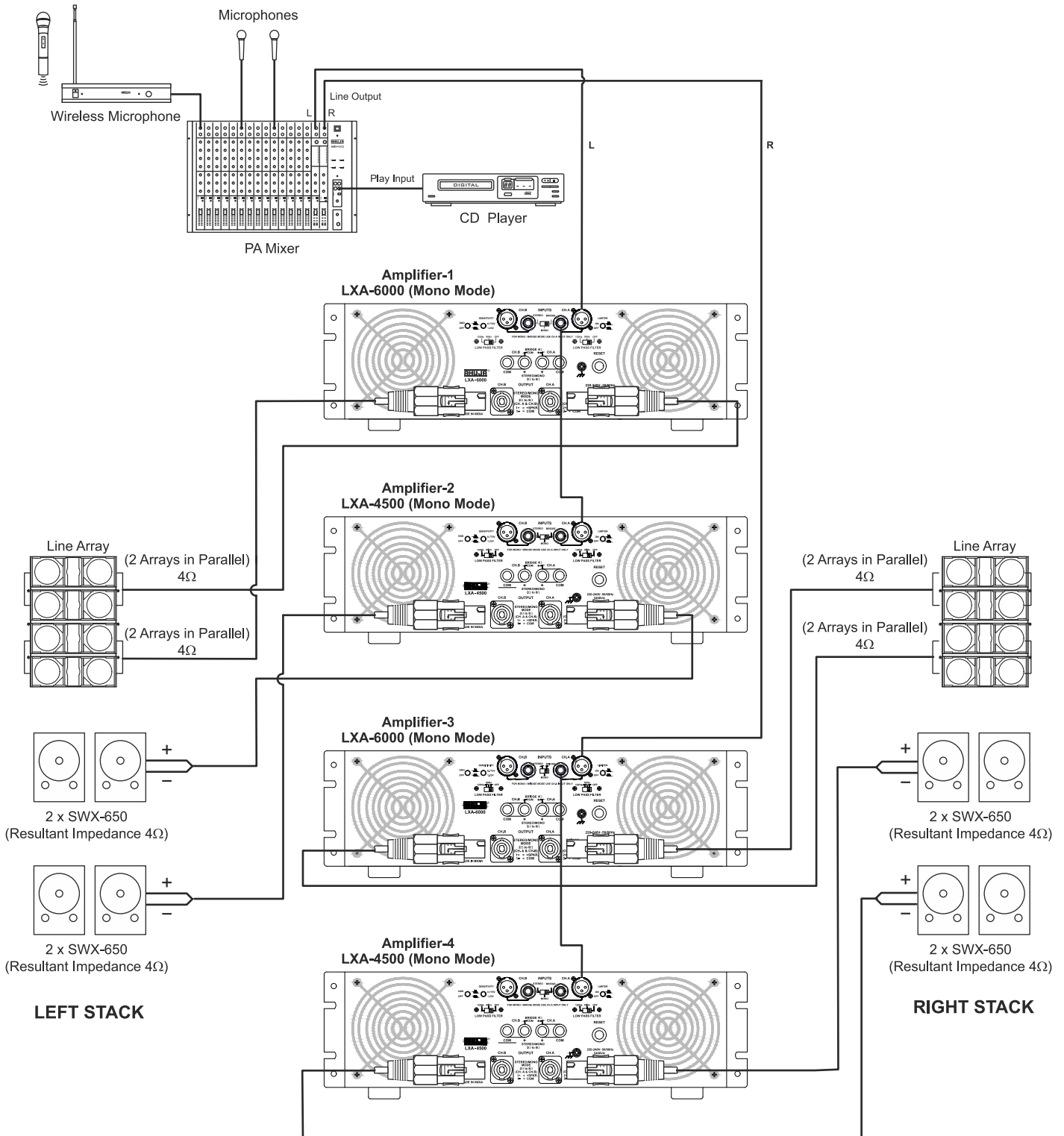

• Typical Applications

- Connect the Left output of the Audio mixing console to the channel A input of Amplifier-1 (LXA-6000).
- Connect the 6.3mm jack input of channel A in Amplifier-1 to the XLR input channel A of Amplifier-2 (LXA-4500).
- The inputs can be wired as per fig. 1 & 2 (*Input connections for Balanced and Unbalanced Mode*).
- For connecting 4 nos. of Line Array cabinets, connect 2 nos. in parallel on outputs A and connect another 2 nos. in parallel on output B of Amplifier-1 (LXA-6000). The resultant impedance of each group of two Line Arrays is 4 ohm.
- Connect 2 Nos. of SWX-650 in parallel on channel A output of Amplifier-2 (LXA-4500) and another set of two nos. SWX-650 in parallel on channel B output of Amplifier-2 LXA-4500. The resultant impedance of each stack of SWX-650 is 4Ω.
- Switch the Stereo/Mono/Bridge switch of each Amplifier-1 and 2 to Mono mode.
- For Amplifier-1, keep the Low Pass filter switch in OFF position. For Amplifier-2 keep the Low Pass filter switch in either 80 Hz or 120 Hz positions.
- This installation of four Subwoofers SWX-650 and four Line Arrays connected to LXA-4500 and LXA-6000 respectively is LEFT STACK of Line Array.
- Connect the Right output of the Audio mixing console to the channel A input of Amplifier-3 (LXA-6000).
- Connect the 6.3mm jack input of channel A in Amplifier-3 to the XLR input channel A of Amplifier-4 (LXA-4500).
- The inputs can be wired as per fig. 1 & 2 (*Input connections for Balanced and Unbalanced Mode*).
- For connecting 4 nos. of Line Array cabinets, connect 2 nos. in parallel on outputs A and connect another 2 nos. in parallel on output B of Amplifier-3 (LXA-6000). The resultant impedance of each group of two Line Arrays is 4 ohm.
- Connect 2 Nos. of SWX-650 in parallel on channel A output of Amplifier-4 (LXA-4500) and another set of two nos. SWX-650 in parallel on channel B output of Amplifier-4 LXA-4500. The resultant impedance of each stack of SWX-650 is 4Ω.
- Switch the Stereo/Mono/Bridge switch of each Amplifier-3 and 4 to Mono mode.
- For Amplifier-3, keep the Low Pass filter switch in OFF position. For Amplifier-4 keep the Low Pass filter switch in either 80 Hz or 120 Hz positions.
- This installation of four Subwoofers SWX-650 and four Line Arrays connected to LXA-4500 and LXA-6000 respectively is RIGHT STACK of Line Array.
- Finally adjustment of output levels will be by their respectively volume controls of each channel of Amplifier-1, 2, 3 and 4.
- Any adjustments in the tonal quality of the sound, if required, can be made from the audio mixing console.
- Operate each Amplifier below the threshold of clip LED glow.

• Protections & Installations

Thermal Protections

Output Devices/Transformer

In case of excessive heating of the output devices or transformer, the thermal protection circuits will bring the audio signal to mute status. Onset of thermal protection circuit is indicated by glowing of TEMP LEDs (yellow) in each channel. To restore normal operating conditions, it is recommended to switch off the amplifier for cooling and then switch ON again after cooling and checking the speaker connections.

DC, RFI Protection

Inbuilt circuits are provided to protect the loudspeakers from any offset DC voltages. Also suppression filters at primary and secondary power supplies have been inbuilt, to reduce some RF interference.

Overload / Short Circuit Protection

Protection circuit is provided in both channels for the safety of output devices in case of overload or mismatch of impedances at the outputs. This circuit brings the input signals to mute condition, and set will be in protect mode. To reset, switch OFF the amplifier for few seconds, remove the short circuit or overload and then switch ON for normal operation.

Fuses/CIRCUIT PROTECTOR

- 1 × 20 A Circuit Protector for AC mains.
- 4 × 25 (T 25A L) fuses for +ve and -ve DC supply
- 2 × 3 A (T 3AL) fuses for ±13V regulated power supplies.

19" Rack Installation

- The amplifier is designed for use in a standard 19" rack with height of 3U units.
- In order to provide sufficient support base to the heavy amplifier, it is essential to use the 19" rack system with side support channels.
- The installed amplifier, should be well supported by the side support channels as well as rigidly fixed on to the rack through the two rack mount side brackets duly fitted with 'U' type handles, as shown in the figure below:

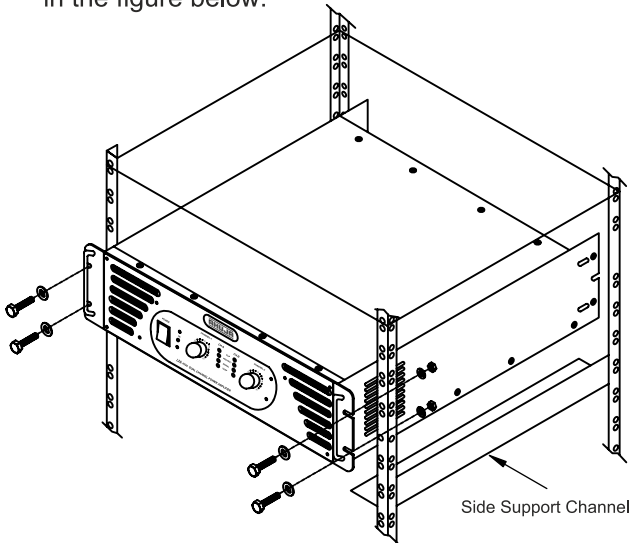
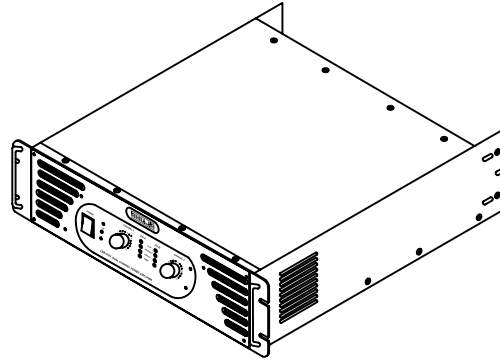

Table Top Usage

- The 'U' handles are helpful in easy portability of the amplifier for table top usage. Do not keep the set on an unstable stand or tripod.



• Trouble Shooting

Key to LED symbols:



GLOWING



BLINKING



OFF

Condition: Normal operation

Indication:



ON



CLIP



PROTECT



SIGNAL



TEMP

Possible Reason:

- The amplifier is in normal operation (When signal is fed).

Condition: No power to the amplifier

Indication:



ON



CLIP



PROTECT























SIGNAL



TEMP

Possible Reason:

- The amplifier power switch may be off.
- The amplifier may not be plugged into the power receptacle.
- Confirm that the AC outlet works by plugging in another device. If too many amplifiers are used on one outlet, the building's circuit breaker may trip and shut off power.
- An overload may cause the AC fuse to blow. Check the AC fuse and replace it by a fuse of same rating.
- An amplifier which keeps shutting off may have a serious internal fault. Turn it off, remove AC power cord and get the amplifier serviced by a qualified technician.

Condition: Low output	
<p>Indication:</p> <div style="display: flex; justify-content: space-between;"> <div style="border: 1px dashed gray; padding: 5px; width: 45%;">  ON </div> <div style="border: 1px dashed gray; padding: 5px; width: 45%;"> <ul style="list-style-type: none">  CLIP  PROTECT  SIGNAL  TEMP </div> </div>	<p>Possible Reason:</p> <ul style="list-style-type: none"> ■ Check if the level of the input signal is too low. ■ Check the signal source is operating and the input cable is intact. ■ The channel volume control setting is too low.
Condition: No Sound	
<p>Indication:</p> <div style="display: flex; justify-content: space-between;"> <div style="border: 1px dashed gray; padding: 5px; width: 45%;">  ON </div> <div style="border: 1px dashed gray; padding: 5px; width: 45%;"> <ul style="list-style-type: none">  CLIP  PROTECT  SIGNAL  TEMP </div> </div>	<p>Possible Reason:</p> <ul style="list-style-type: none"> ■ The amplifier may be in mute mode due to speaker impedance mismatch or output short circuit. ■ Check the speaker impedance and speaker wiring for stray strands or breaks in the insulation. ■ To restore normal operation, turn down the volume control, switch OFF the set for few seconds and switch ON again. Increase the volume control slowly for the desired output.
Condition: No Sound	
<p>Indication:</p> <div style="display: flex; justify-content: space-between;"> <div style="border: 1px dashed gray; padding: 5px; width: 45%;">  ON </div> <div style="border: 1px dashed gray; padding: 5px; width: 45%;"> <ul style="list-style-type: none">  CLIP  PROTECT  SIGNAL  TEMP </div> </div>	<p>Possible Reason:</p> <ul style="list-style-type: none"> ■ The amplifier may be in mute mode due to output short circuit, overloading or poor ventilation resulting in the rise in temperature either of output devices or power transformer as indicated by respective LEDs to unsafe region. ■ Switch off the amplifier to cool down. ■ Check if the fan is working, proper ventilation is provided and output connections are as recommended, remove the fault if any. ■ This could be due to wrong speaker connections or faulty speakers. ■ Check the output speaker connections as per fig. 3 or 4 on page no. 7 (<i>Output Connections for Stereo, Mono or Bridge Mode</i>). ■ To restore normal operation, turn down the volume control, than switch ON the set and increase the volume control for desired output.
Condition: NO Sound	
<p>Indication:</p> <div style="display: flex; justify-content: space-between;"> <div style="border: 1px dashed gray; padding: 5px; width: 45%;">  ON </div> <div style="border: 1px dashed gray; padding: 5px; width: 45%;"> <ul style="list-style-type: none">  CLIP  PROTECT  SIGNAL  TEMP </div> </div>	<ul style="list-style-type: none"> ■ Amplifier has gone to protect mode due to high signal level, high temperature or output short or overloading. ■ Check the level of signal from input source. If it is high then reduce the input signal level and than switch ON the amplifier and increase volume slowly. ■ The amplifier should never be operated at a level which causes the clip LEDs to illuminate continuously. It will give distorted sound. ■ Also check the impedance of speakers, shorting of speaker connections if any. Rectify the fault and then switch ON the amplifier for normal operation.

• Specifications

Model	LXA-4500	
Continuous Rated Power		
Stereo/Mono	8Ω	2 × 1000W RMS
	4Ω	2 × 1550W RMS
	2Ω	2 × 2250W RMS
Bridged Output	8Ω	3100W RMS
	4Ω	4500W RMS
THD + N	< 1.0%	
Frequency Response (-1dB)	20-20,000Hz	
Power Bandwidth (0.5% THD)	20-20,000Hz	
Input Sensitivity	0dBu (775mV), 4dBu (1.23V)	
Input Impedance	10K Unbalanced, 20K Balanced	
S / N Ratio	> 95dB	
LPF	80 Hz/120Hz, 24dB per octave	
Channel Separation	> 65dB at 1kHz	
Damping Factor (8Ω)	> 500	
Slew Rate	35V/μs	
Protections	Temperature, DC, RFI, Short Circuit, Overload, Built-in Limiter with ON/OFF AC: Circuit Protector 20A ± DC: Fuse 2 x 25A (T 25A L) for each zone, Fuse 2×3A (T 3A L)	
Input Connectors	2 × XLR, Stereo Phone Jack 6.3mm	
Output Connectors	Speakon 4-Way and heavy duty Binding Post for each channel	
Cooling	Variable Speed DC Fan with Temperature Sensing	
Front Panel Controls	2 × 41 step level Attenuators	
Indicators	ON Signal, Clip, Temperatures, Protect (Ch. A & B)	
Power Consumption (Rated)	5400VA @ 220-240V 50/60Hz	
Dimensions	W482 × H153 × D580mm	
Weight	36.50kg Approx.	

AHUJA RADIOS • 215, Okhla Industrial Estate, New Delhi - 110 020, INDIA
 Tel.: +91-11-26831549, 41612474 Fax : +91-11-26847287
 E-mail: ahuja@ahujaradios.com, admin@ahujaradios.com
 Website: www.ahujaradios.com

- Design and Specifications are subject to change without notice owing to continuous product up-gradation
- Technical specifications are subject to production tolerances.
- We cannot be held responsible for printing errors, should they occur.
- AHUJA is a registered trademark of Ahuja Radios in India and other countries.
- © Copyright Ahuja Radios, 2024. All rights reserved. Any unauthorized reproduction or use of logos, images or design elements is strictly prohibited by law.
- No part of this compilation may be reproduced in any manner or translated without written permission.

